

PTZ-N4225I-DE(H) 2 MP 25 × IR Network Speed Dome



- Four-inch 2 MP camera with pan, tilt and zoom (25 ×) ability
- Efficient H.265+ compression technology to save bandwidth and storage
- Clear imaging against strong back light due to 120 dB true WDR technology
- Excellent night-time performance with up to 100 m enhanced IR
- Water and dust resistant (IP66)

▪ Specification

Camera	
Image Sensor	1/2.8" progressive scan CMOS
Max. Resolution	1920 × 1080
Min. Illumination	Color: 0.005 Lux @(F1.6, AGC ON), B/W: 0.001 Lux @(F1.6, AGC ON), 0 Lux with IR
Shutter Speed	1/1 s to 1/30,000 s
Day & Night	IR Cut Filter
Zoom	25 × optical, 16 × digital
Lens	
Focal Length	4.8 mm to 120 mm, 25 × optical
FOV	Horizontal field of view: 57.6° to 2.5° (Wide-Tele), Vertical field of view: 34.4° to 1.4° (Wide-Tele), Diagonal field of view: 64.5° to 2.9° (Wide-Tele)
Focus	Auto, semi-auto, manual
Aperture	Max. F1.6
Zoom Speed	Approx. 3.6 s (optical lens, wide-tele)
Illuminator	
Supplement Light Type	IR
Supplement Light Range	Up to 100 m
Smart Supplement Light	Yes
PTZ	
Movement Range (Pan)	360° endless
Movement Range (Tilt)	From -15° to 90° (Auto-flip)
Pan Speed	Configurable, from 0.1°/s to 80°/s, Preset Speed: 80°/s
Tilt Speed	Configurable, from 0.1°/s to 80°/s, Preset Speed: 80°/s
Proportional Pan	Yes
Presets	300
Preset Freezing	Yes
Patrol Scan	8 patrols, up to 32 presets for each patrol
Pattern Scan	4 pattern scans, record time over 10 minutes for each scan
Park Action	Preset/Pattern Scan/Patrol Scan/Auto Scan/Tilt Scan/Random Scan/Frame Scan/Panorama Scan
PTZ Status Display	Yes
Scheduled Task	Preset/Pattern Scan/Patrol Scan/Auto Scan/Tilt Scan/Random Scan/Frame Scan/Panorama Scan/Dome Reboot/Dome Adjust
Power-off Memory	Yes
Video	
Main Stream	50Hz: 25fps (1920 × 1080, 1280 × 960, 1280 × 720), 60Hz: 30fps (1920 × 1080, 1280 × 960, 1280 × 720)
Sub-Stream	50Hz: 25fps (704 × 576, 640 × 480, 352 × 288), 60Hz: 30fps (704 × 480, 640 × 480, 352 × 240)
Third Stream	50Hz: 25fps (1920 × 1080, 1280 × 960, 1280 × 720, 704 × 576, 640 × 480, 352 × 288), 60Hz: 30fps (1920 × 1080, 1280 × 960, 1280 × 720, 704 × 480, 640 × 480, 352 × 240)
Video Compression	Main Stream: H.265+/H.265/H.264+/H.264, Sub-Stream: H.265/H.264/MJPEG, Third Stream: H.265/H.264/MJPEG

Video Bit Rate	32 Kbps to 16384 Kbps
H.264 Type	Baseline Profile/Main Profile/High Profile
H.265 Type	Main Profile
Scalable Video Coding (SVC)	H.264 and H.265 encoding
Region of Interest (ROI)	Main stream, sub-stream and third stream respectively support four fixed areas
Audio	
Audio Compression	G.711alaw/G.711ulaw/G.722/G.726/MP2L2/PCM
Audio Bit Rate	64 Kbps (G.711)/16 Kbps (G.722.1)/16 Kbps (G.726)/32 Kbps to 160 Kbps (MP2L2)
Network	
Protocols	IPv4/IPv6, HTTP, HTTPS, 802.1x, QoS, FTP, SMTP, UPnP, SNMP, DNS, DDNS, NTP, RTSP, RTCP, RTP, TCP/IP, UDP, IGMP, ICMP, DHCP, PPPoE, Bonjour, Websocket, Websockets
Simultaneous Live View	Up to 20 channels
API	Open Network Video Interface, ISAPI, SDK, ISUP
User/Host	Up to 32 users. 3 levels: Administrator, Operator and User
Security	User authentication (ID and PW), Host authentication (MAC address); HTTPS encryption; IEEE 802.1x port-based network access control; IP address filtering
Network Storage	NAS (NPS, SMB/ CIFS), ANR
Client	iVMS-4200, HiLookVision
Web Browser	IE10-11, Chrome 57+, Firefox 52+, Safari 12+
Image	
Image Settings	Saturation, brightness, contrast, sharpness, gain, and white balance adjustable by client software or web browser
Wide Dynamic Range (WDR)	120 dB
Defog	Digital defog
Image Stabilization	No
Image Enhancement	BLC, HLC, 3D DNR
Privacy Mask	24 programmable privacy masks
Regional Focus	Yes
Regional Exposure	Yes
Interface	
Ethernet Interface	1 RJ45 10 M/100 M Ethernet Interface; PoE (802.3 at, class4)
On-board Storage	Built-in memory card slot, support Micro SD/SDHC/SDXC, up to 256 GB
Audio	1 input (line in), max. input amplitude: 2-2.4 vpp, input impedance: 1 K Ω \pm 10%; 1 output (line out), line level, output impedance: 600 Ω
Event	
Basic Event	Motion Detection, Video Tampering Detection, Exception Detection
Smart Event	Intrusion Detection, Line Crossing Detection, Region Entrance Detection, Region Exiting Detection, Unattended Baggage Detection, Object Removal Detection, Audio Exception Detection
General	
Power	12 VDC, 2.0 A & PoE (802.3at), 42.5 to 57 VDC, 0.6 A, class4 Max.:18 W (IR Max.6 W)
Dimension	\varnothing 166 mm \times 289.6 mm (\varnothing 6.54" \times 11.4")
Weight	Approx. 2.5 kg (5.51 lb)
Material	ADC 12, PC+10% GF
Operating Condition	-30 $^{\circ}$ C to 65 $^{\circ}$ C (-22 $^{\circ}$ F to 149 $^{\circ}$ F). Humidity 90% or less (non-condensing)

Approval	
EMC	FCC (47 CFR Part 15, Subpart B); CE-EMC (EN 55032: 2015, EN 61000-3-2:2019, EN 61000-3-3:2013+A1:2019, EN 50130-4: 2011 +A1: 2014); RCM (AS/NZS CISPR 32: 2015); IC (ICES-003: Issue 7); KC (KN 32: 2015, KN 35: 2015)
Safety	UL (UL 62368-1) CB (IEC 62368-1:2014+A11); CE-LVD (EN 62368-1:2014+A11:2017), BIS (IS 13252(Part 1):2010/ IEC 60950-1: 2005); LOA (IEC/EN 60950-1)
Environment	CE-RoHS (2011/65/EU); WEEE (2012/19/EU); Reach (Regulation (EC) No 1907/2006)
Protection	IP66 (IEC 60529-2013), 4000V Lightning Protection, Surge Protection and Voltage Transient Protection

▪ Available Model

PTZ-N4225I-DE(G)



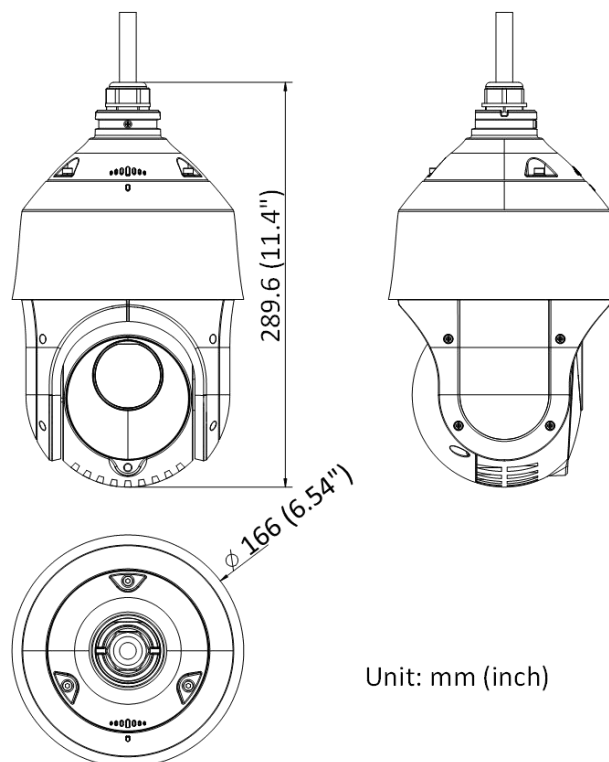







▪ Dimension



Unit: mm (inch)

▪ Accessory

▪ Optional

HIA-B471-P Vertical pole mount	HIA-B471-BP Vertical pole mount	HIA-B471-C Corner mount	HIA-B471-B Wall Mount	HIA-B473 Wall Mount
				
HIA-B171 Pendant mount	HIA-B471-BC Corner mount	HIA-B371 Pendant mount	HIA-B173 Pendant mount	HIA-B172 Pendant mount
				
HIA-B471 Wall Mount	HIA-B571 In-ceiling mount	HIA-B472 Wall Mount		
